



Transmitter

Technical data

	FLUXUS F831 (831-AA1)	FLUXUS F831 (831-AA2)
		
design	explosion-proof field device zone 1 (intrinsic safety: HART)	explosion-proof field device zone 1 (intrinsic safety: inputs, HART)
measurement		
measurement principle	transit time difference correlation principle, automatic NoiseTrek selection for measurements with high gaseous or solid content	
synchronised channel averaging	x (2 measuring channels necessary)	
flow velocity	m/s	measuring range: 0.01...25
repeatability	0.15 % MV ±0.005 m/s	
fluid	all acoustically conductive liquids with < 10 % gaseous or solid content in volume (transit time difference principle)	
temperature compensation	corresponding to the recommendations in ANSI/ASME MFC-5.1-2011	
measurement uncertainty (volumetric flow rate)		
measurement uncertainty of the measuring system ¹	±0.3 % MV ±0.005 m/s	
measurement uncertainty at the measuring point ²	±1 % MV ±0.005 m/s (see also graphical presentation)	
transmitter		
power supply	20...32 V DC, U _m = 120 V	
power consumption	W	< 4
number of measuring channels	1, optional: 2	
damping	s	0...100 (adjustable)
measuring cycle	Hz	100...1000 (1 channel)
response time	s	1 (1 channel), option: 0.02
housing material	cast aluminum, special heavy-duty coating	
degree of protection	IP66	
dimensions	mm	see dimensional drawing
weight	kg	6.5
fixation	wall mounting, 2" pipe mounting	
ambient temperature	°C	-40...+60 (< -20 without operation of the display)
display	128 x 64 pixels, backlight	
menu language	English, German, French, Spanish, Dutch, Russian, Polish, Turkish, Italian	
explosion protection		
• ATEX/IECEX		
marking	CE 0637  II 2G II 2D Ex db eb ia IIC T6 Gb Ex tb ia IIIC T100 °C Db T _a -40...+60 °C	CE 0637  II (1) 2G II (1) 2D Ex db eb ia [ia] IIC T6 Gb Ex tb ia [ia] IIIC T100 °C Db T _a -40...+60 °C
certification ATEX	IBExU20ATEX1103 X	IBExU20ATEX1103 X
certification IECEX	IECEX IBE 20.0015X	IECEX IBE 20.0015X
measuring functions		
physical quantities	volumetric flow rate, mass flow rate, flow velocity	
totaliser	volume, mass	
calculation functions	average, difference, sum (2 measuring channels necessary)	
diagnostic functions	sound speed, signal amplitude, SNR, SCNR, standard deviation of amplitudes and transit times	
communication interfaces		
service interfaces	measured value transmission, parametrisation of the transmitter: USB ³	
process interfaces	HART (intrinsic safety, optional)	
accessories		
data transmission kit	USB cable	
software	<ul style="list-style-type: none"> FluxDiagReader: reading of measured values and parameters, graphical presentation FluxDiag (optional): reading of measurement data, graphical presentation, report generation, parametrisation of the transmitter 	
data logger		
loggable values	all physical quantities, totalised physical quantities and diagnostic values	
capacity	max. 800 000 measured values	

¹ with aperture calibration of the transducers

² for transit time difference principle and reference conditions

³ outside the explosive atmosphere (housing cover open)

		FLUXUS F831 (831-AA1)	FLUXUS F831 (831-AA2)
outputs			
		The outputs are galvanically isolated from the transmitter.	
• current output			
number		1	
range	mA	4...20 (3.2...24)	
accuracy		0.04 % MV ±3 µA	
passive output		U _{ext} ≤ 29 V DC, depending on R _{ext} (R _{ext} < 830 Ω at 29 V)	
current output in HART mode			
• range	mA	4...20 (3.5...22)	
• passive output		U _{ext} = 9...29 V DC	
intrinsic safety parameters		U _i = 29 V I _i = 100 mA P _i = 0.725 W C _i = 1 nF L _i = 50 nH	
inputs			
• temperature input			
number		max. 1	
type		Pt100/Pt1000	
connection		4-wire	
range	°C	-150...+560	
resolution	K	0.01	
accuracy		±0.01 % MV ±0.03 K	
intrinsic safety parameters		U _o = 9.2 V I _o = 25 mA P _o = 0.057 W C _o = 4283 nF L _o = 57 mH	
• current input			
number		max. 1	
accuracy		±0.1 % MV ±0.01 mA	
active input		U _{int} < 20 V, R _{int} = 360 Ω	
• range	mA	0...20	
• intrinsic safety parameters		U _o = 29.2 V I _o = 88 mA P _o = 0.64 W C _o = 73 nF L _o = 4.1 mH	

¹ with aperture calibration of the transducers

² for transit time difference principle and reference conditions

³ outside the explosive atmosphere (housing cover open)

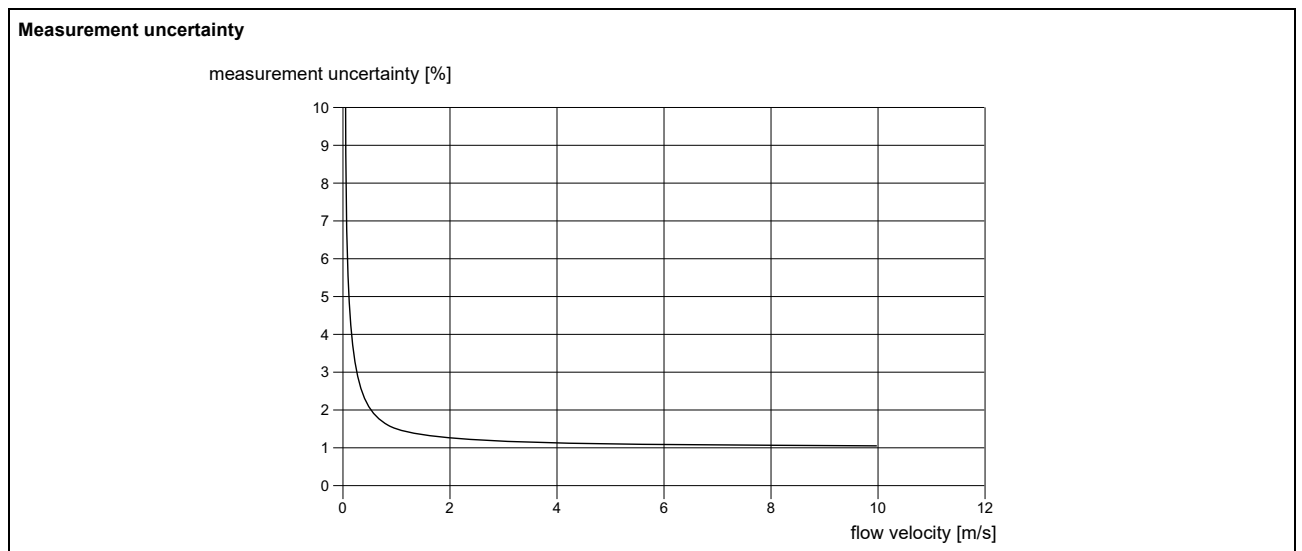

Dimensions

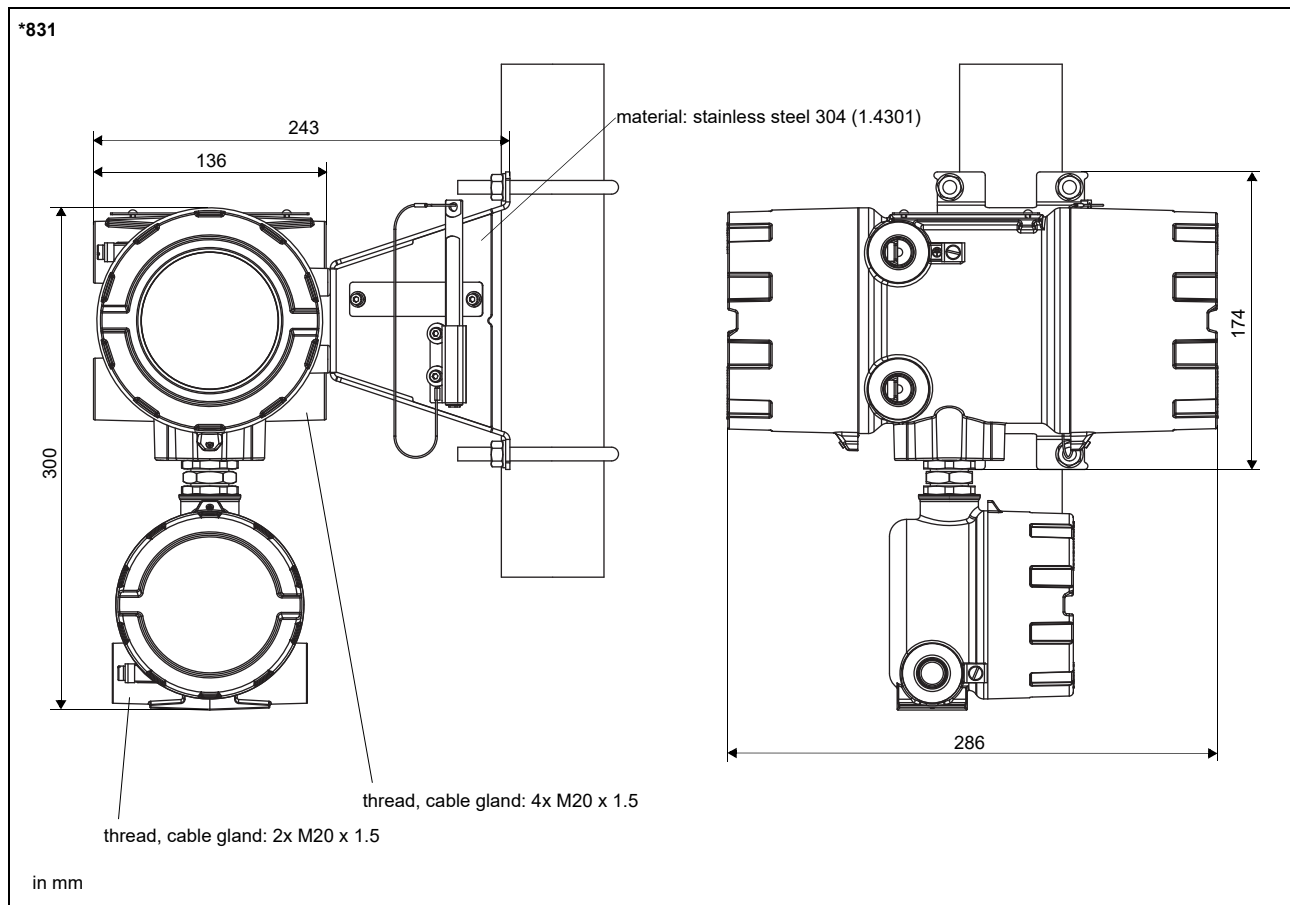

2" pipe mounting kit

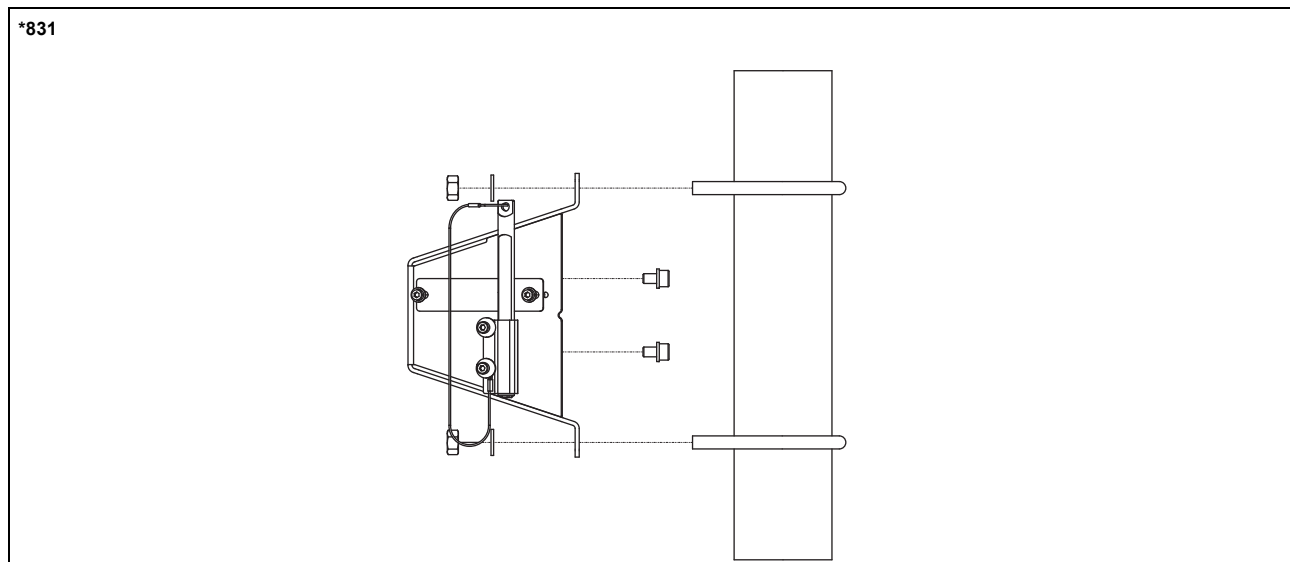

Storage

- store within the original package
- keep all openings closed
- protect against sunlight
- store in a dry and dust-free place
- do not store outdoors
- storing temperature: -40...+60 °C

Terminal assignment

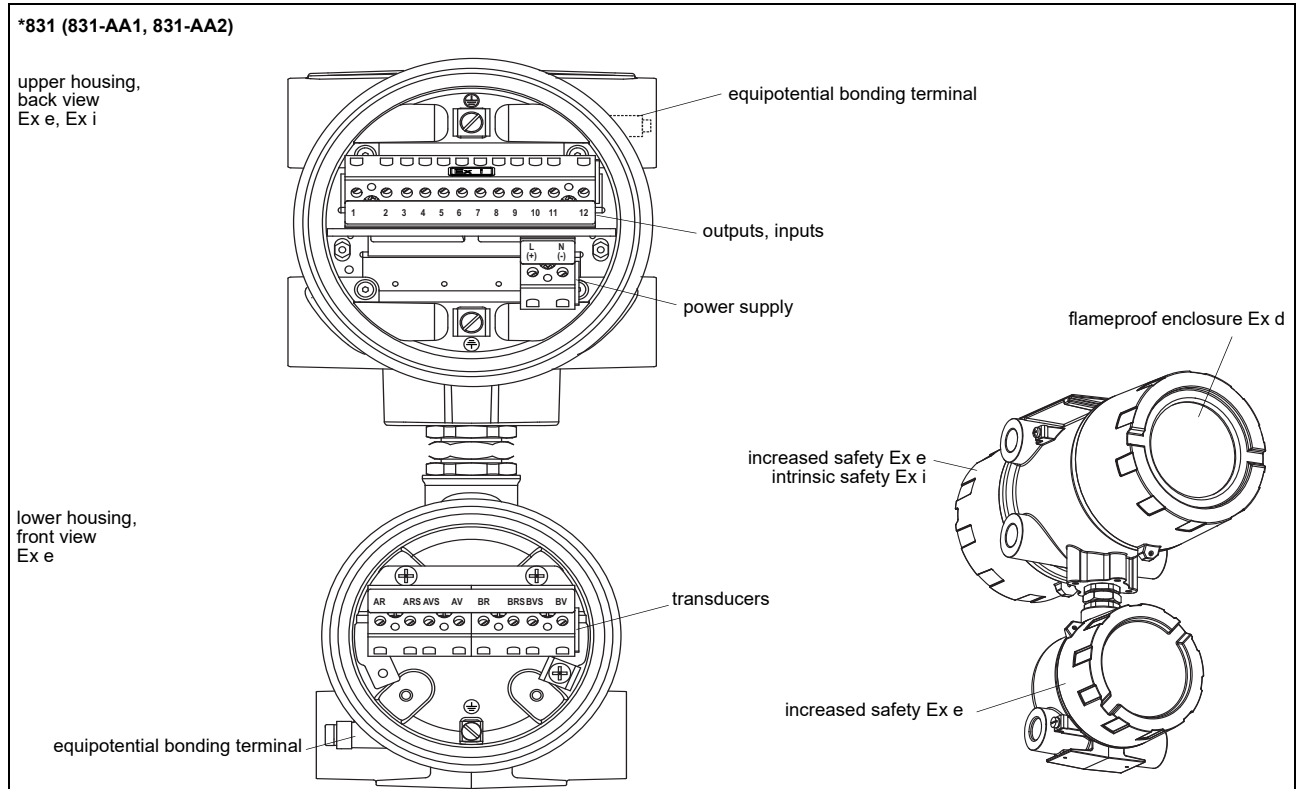

power supply ¹				
DC				
terminal		connection		
(+) (+)		+		
(-) (-)		-		
transducers, extension cable				
measuring channel A		measuring channel B		transducer
terminal	connection	terminal	connection	
AV	signal	BV	signal	↑
AVS	internal shield	BVS	internal shield	↑
ARS	internal shield	BRS	internal shield	↑
AR	signal	BR	signal	↑
cable gland	external shield	cable gland	external shield	↑ ↑
outputs ^{1, 2}				
terminal		connection		
11+, 12-		current output, HART		
USB	type C Hi-Speed USB 2.0 Device	service (FluxDiag/FluxDiagReader)		
inputs ²				
temperature probe				
terminal		direct connection	connection with extension cable	
3		red	red	
4		red/blue	blue	
5		white/blue	grey	
6		white	white	
current input ¹				
terminal		connection		
1		-		
2		+		

¹ cable (by customer): e.g. flexible wires, with insulated wire ferrules, wire cross-section: 0.25...2.5 mm²

² The number, type and terminal assignment are customised.





Transducers

Shear wave transducers

	technical type					
	G	K	M	P	Q	
zone 1 normal temperature range	CDG1N81 CLG1N81	CDK1N81 CLK1N81	CDM2N81 CLM2N81	CDP2N81 CLP2N81	CDQ2N81 CLQ2N81	
zone 1 IP68	CDG1LI1	CDK1LI1	CDM2LI1	CDP2LI1		
zone 1 extended temperature range	CDG1E83 CLG1E83	CDK1E83 CLK1E83	CDM2E85 CLM2E85	CDP2E85 CLP2E85	CDQ2E85 CLQ2E85	
inner pipe diameter d						
min. extended	mm	400	100	50	25	10
min. recommended	mm	500	200	100	50	25
max. recommended	mm	4000	2000	1000	400	150
max. extended	mm	6500	2400	1200	480	240
pipe wall thickness						
min.	mm	11	5	2.5	1.2	0.6

for further data see Technical specification TS_F8xx-transducersVx-xxx_Leu

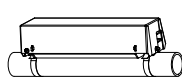
Transducer mounting fixture

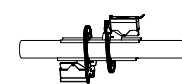
Variofix L	Variofix L with bolt mounting plates	Variofix C	Variofix C with bolt mounting plates	transducer box WI for Wavelinjector
				
	outer pipe diameter: max. 48 mm		outer pipe diameter: VC M: max. 46 mm VC Q: max. 36 mm	

for further data see Technical specification TS_F8xx-transducersVx-xxx_Leu

Coupling materials for transducers

	normal temperature range		extended temperature range			Wavelinjector WI-400	
	< 100 °C	< 170 °C	< 150 °C	< 200 °C	200...240 °C	< 280 °C	280...400 °C
< 24 h	coupling compound type N or coupling foil type VT	coupling compound type E or coupling foil type VT	coupling compound type E or coupling foil type VT	coupling compound type E or H or coupling foil type VT	coupling foil type TF	coupling foil type A and coupling foil type VT	coupling foil type B and coupling foil type VT
long time measurement	coupling foil type VT	coupling foil type VT	coupling foil type VT	coupling foil type VT			

for further data see Technical specification TS_F8xx-transducersVx-xxx_Leu

Connection systems

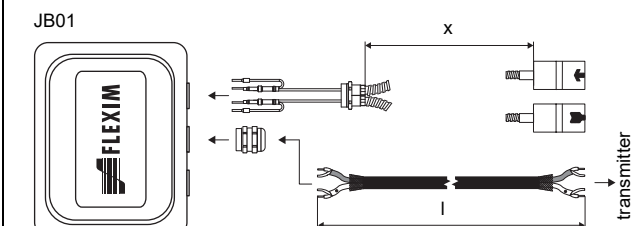
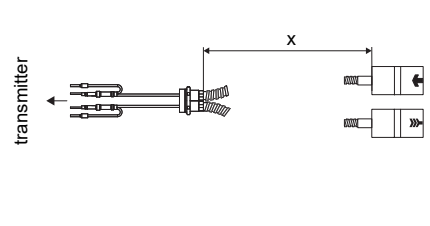
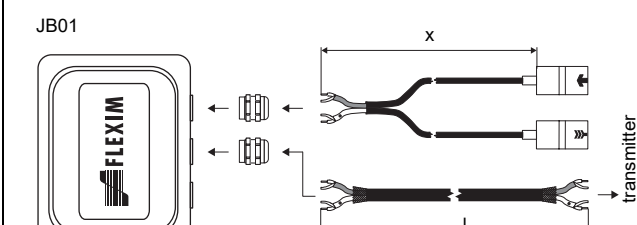
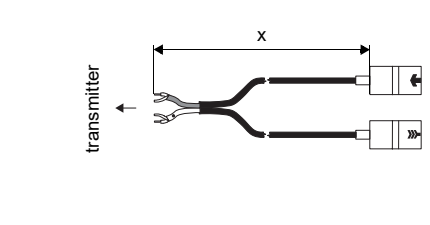
connection system T1		
connection with extension cable	direct connection	transducers technical type
		****G*
		****L*

for further data see Technical specification TS_F8xx-transducersVx-xxx_Leu

Temperature probes

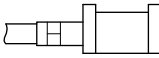
PT12N (order code: ACC-PE-xxxx-/T332)
<ul style="list-style-type: none"> • clamp-on • ATEX-Zone 0 (intrinsic safety)
-45...+230 °C

see Technical specification TS_PTVx-xXX_Leu

Annex

Reference conditions

as available at e.g. the test facilities of Physikalisch-Technische Bundesanstalt

measurement principle		transit time difference correlation principle
all uncertainties	%	95
fluid temperature		25 °C ±5 K
ambient temperature		25 °C ±5 K
warm-up time	min	10
flow profile at the measuring point		fully developed, rotationally symmetric
installation		installation according to specifications using the recommended transducers
Reynolds number		> 10 000
pipe diameter uncertainty	%	0.2
pipe wall thickness uncertainty	%	1
circularity tolerance		0.08 % of inner pipe diameter
SCNR	dB	> 48
SNR	dB	> 12



P. Manuel Girona, 2 08034 Barcelona
Tlf. 932 80 01 01 Fax 932 80 64 16

URL: www.lanasarrate.es
e-mail: lanasarrate@lanasarrate.es